

# **New Tech for Prairie Agriculture**

**Scott Day P.Ag. – Director & Agronomist  
Fall Line Capital Inc.  
San Mateo, California**

**Owner/Manager – Treelane Farms Ltd.  
Deloraine, Manitoba**

**APAS Policy meeting, March 25, 2026**



CONSERVATION-FARM FAMILY  
1998  
DAVID & CLAIRE DAY  
SCOTT, SUE & ALEX DAY  
Marissa Food Elevators Marissa Conservation District Assoc.



NW-22-4-23  
**Treelane Farms**  
The Day Family



# Emmertech

**Robotics & Automation** (SwarmFarm Robotics, Rayhawk, 4AG Robotics)

**Novel Crop Inputs** (Vive Crop Protection, Lucent BioSciences)

**AI & Software** (Ground Truth Ag, ChrysaLabs, IntelliCulture, Ukko Agro)

**Ag-Fintech**







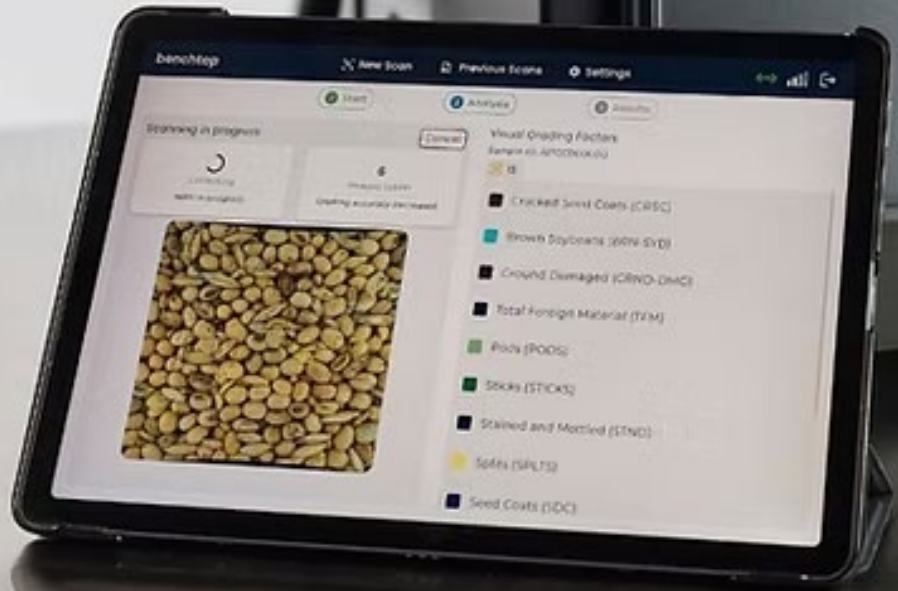

ground  
truth.ag



ETHERNOVIA



ukko

**Sound** 



Verge



## GREENLIGHT BIOSCIENCES

### DESCRIPTION

Platform for producing RNA at high quality and low cost

Applications in Ag (dsRNA)



# Calantha™ provides comparable defoliation protection from Colorado Potato Beetle

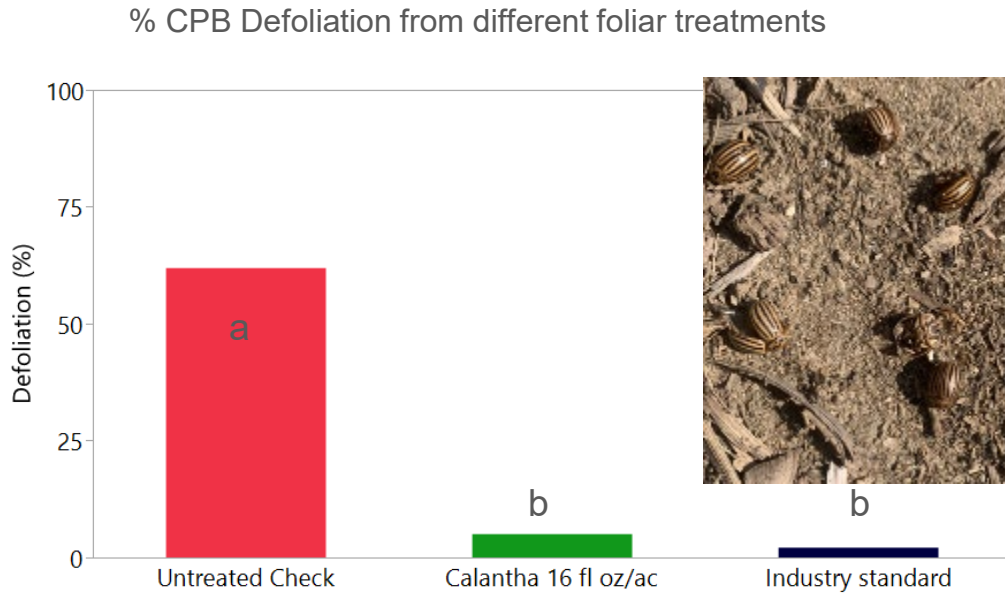

**Weapons of ice that melt to water.**







# GreenLight Bio Product Pipeline

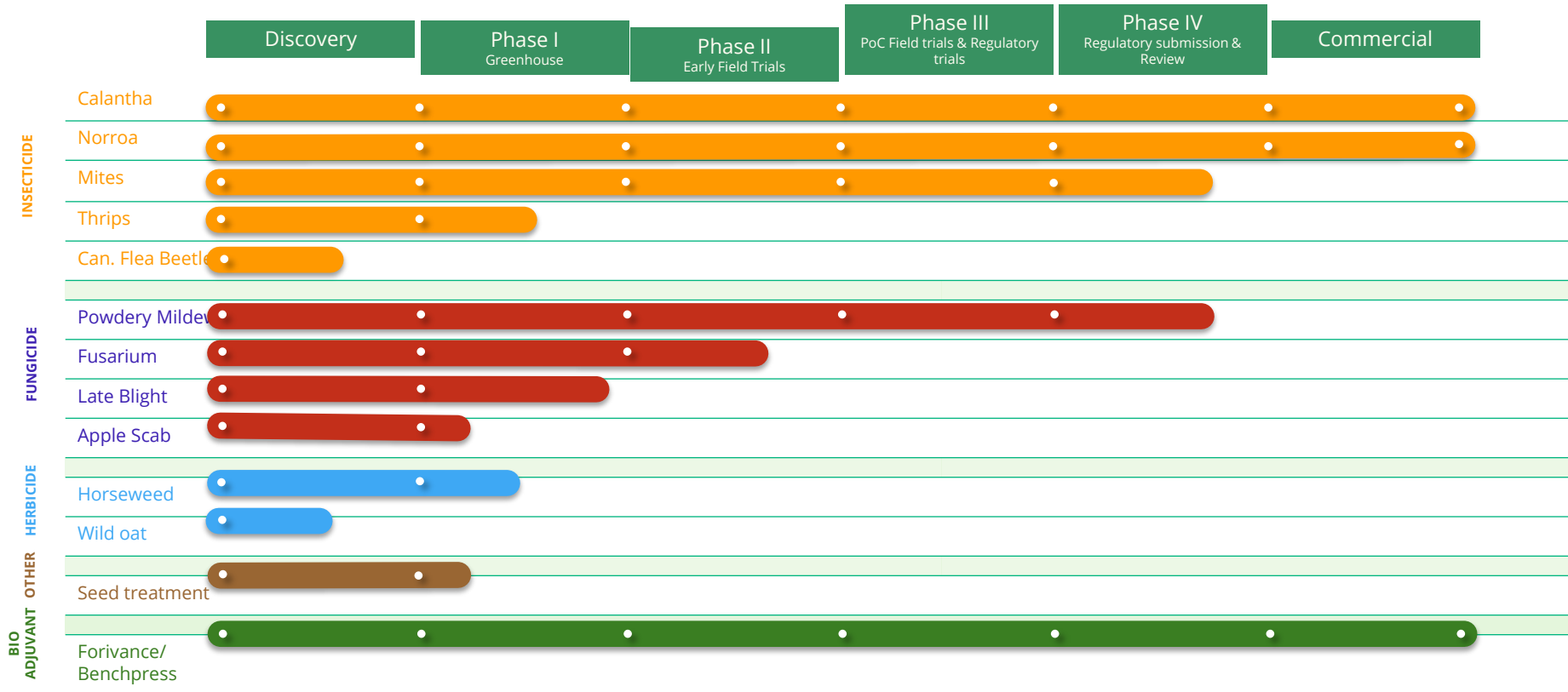

# GreenLight Bio's Canadian Investors & Partners

Fall Line – took company private again after SPAC offering devalued

## Investors



## Funding



## Research Collaborators





# Mazen's First Product: PEDV

demonstrated lactogenic immunity after oral vaccination with maize delivered PEDV antigen



Mean survival rate of all piglets in treatment group

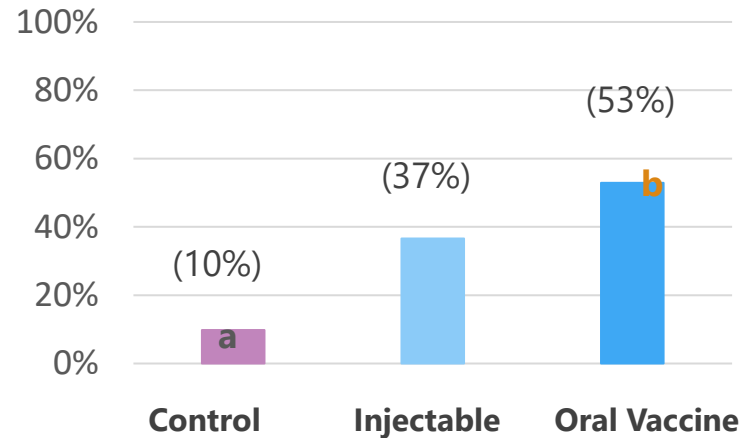

## Viridis BioSi

# FarmerTitan's mobile app & QR codes make it **SUPER EASY** for farms to manager their equipment & team with To Do's, maintenance, repairs,& costs.

**SUPER SIMPLE & EASY** to use... even the "non-tech" guys love it!!



**Favorite Feature:**  
Leaving To Dos, Notes, Issues with Pictures during busy time

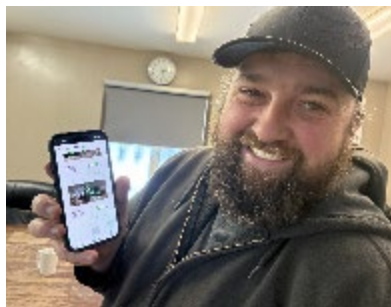

*Jonathan Peters*  
*JP Wiebe Farms (Potatoes)*

**Favorite Feature:**  
Speech to Text



*Rick Friesen*  
*Riconny Farms (Row Crops)*  
*62+ years old*  
*Tech Skills: 1/10*

**Favorite Feature:**  
Scanning QR Code



*Charles (Shop Guy)*  
*Heppells Potatos (Potatoes)*

<https://farmertitan.com/>

# Grain Tracker

Automated digital inventory and traceability  
for field-to-market grain management



### FIELD

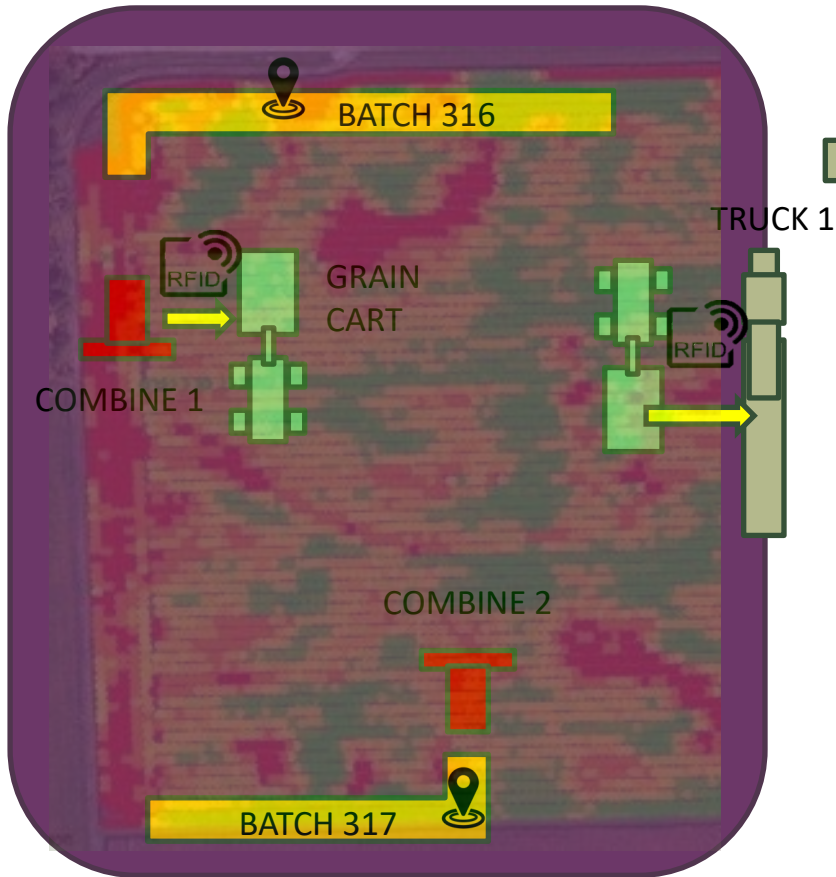

### FARM

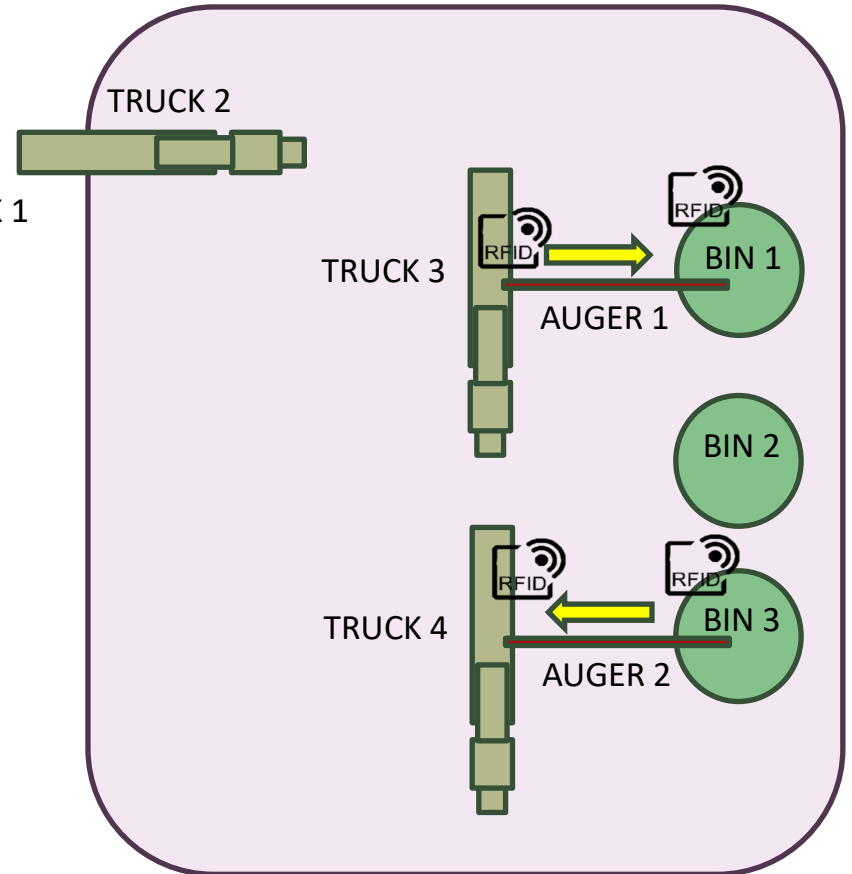

# BIN YARD DASHBOARD

GrainTracker Home Crop Report Inventory Bin Yard Contracts Events Manage Bins Harvest Chain Storage Chain Settings innovationfarmtest@testfarm.com Logout



**Bin 1** Wheat

Bin # **1**  
 Capacity **4,000 Bushels**  
 Filled **50%**  
 Location **50.046574, -97.434789**  
**2,000** Bushels

**Bin 10**

Bin # **10**  
 Capacity **3,000 Bushels**  
 Filled **83.3%**  
 Location **50.046351, -97.433798**  
**2,500** Bushels

**Bin 100** Wet Bin

Bin # **100**  
 Capacity **15,000 Bushels**  
 Filled **100%**  
 Location **50.047533, -97.432065**  
**35,000** Bushels

**Bin 101**

Bin # **101**  
 Capacity **75,000 Bushels**  
 Filled **88%**  
 Location **50.047679, -97.432054**  
**66,000** Bushels

## GT Flow

- Volumetric flow measurement device
- Validation of weight (volume) coming off-of the fields into the bin
- Measurement method for loading trucks to the proper weights

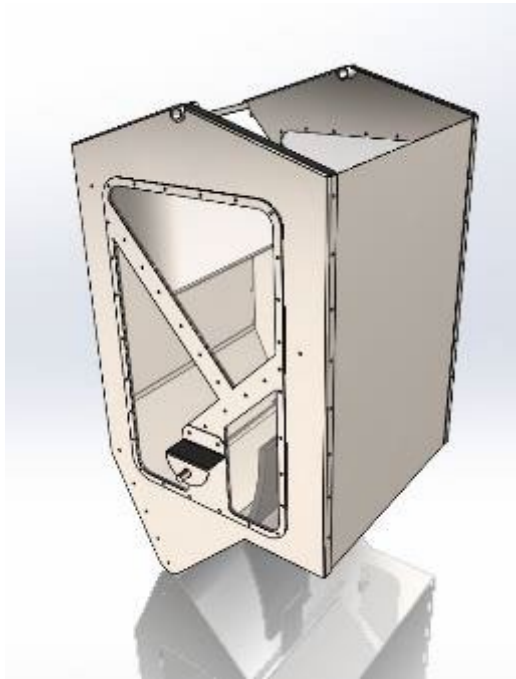

# Farm Health Guardian / Bin Sentry

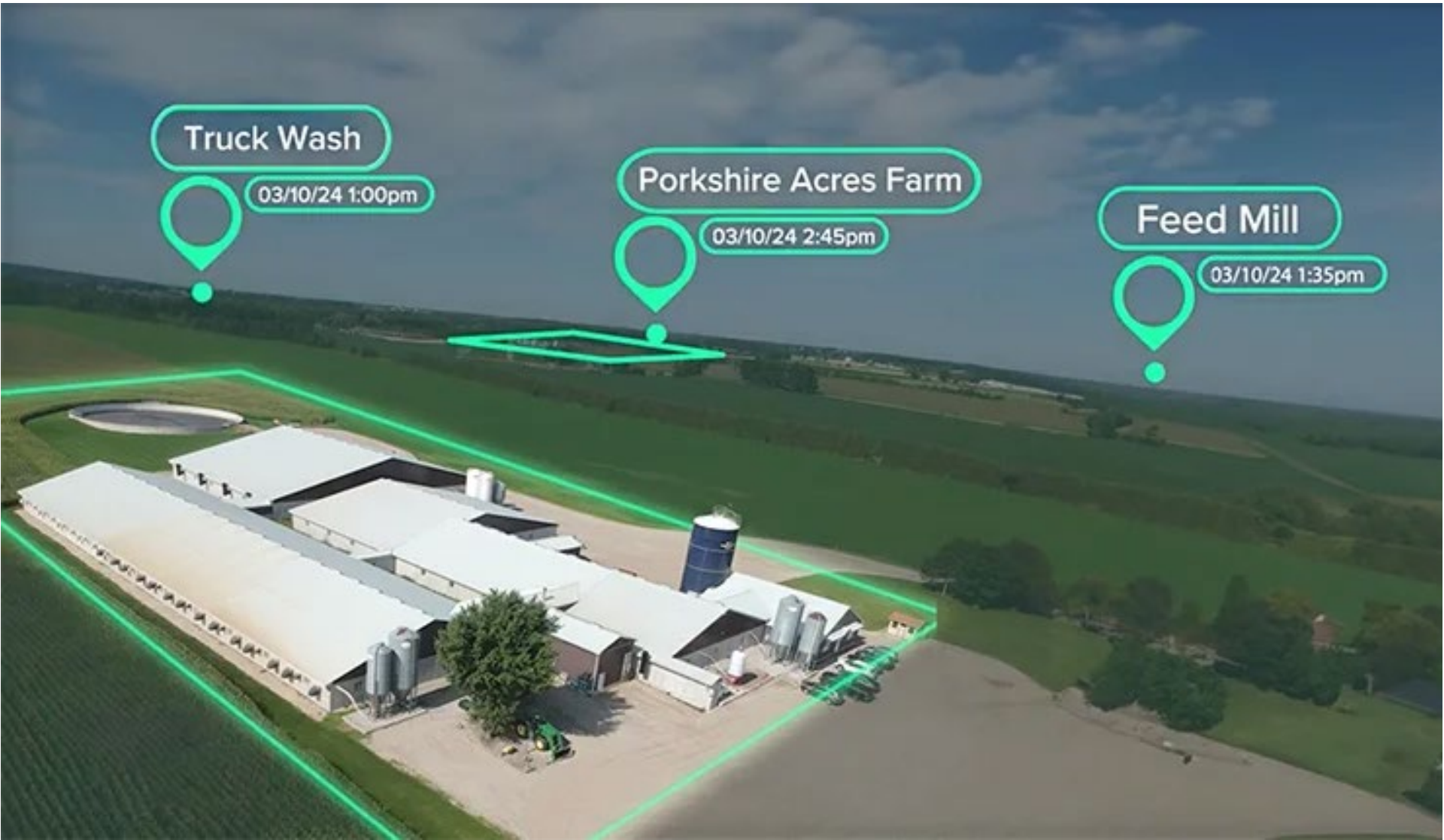

# FarmSee, FloxAI, Targan, YieldX, PheroSyn

Pig #45689  
Weight: 127 lbs  
Status: Lagger

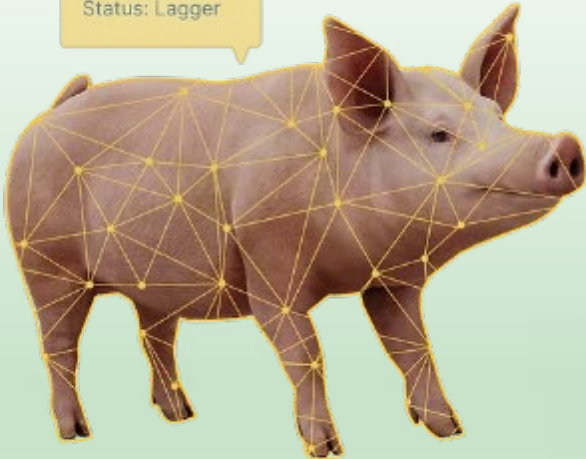

Pig #45689  
Weight: 127 lbs  
Status: Lagger

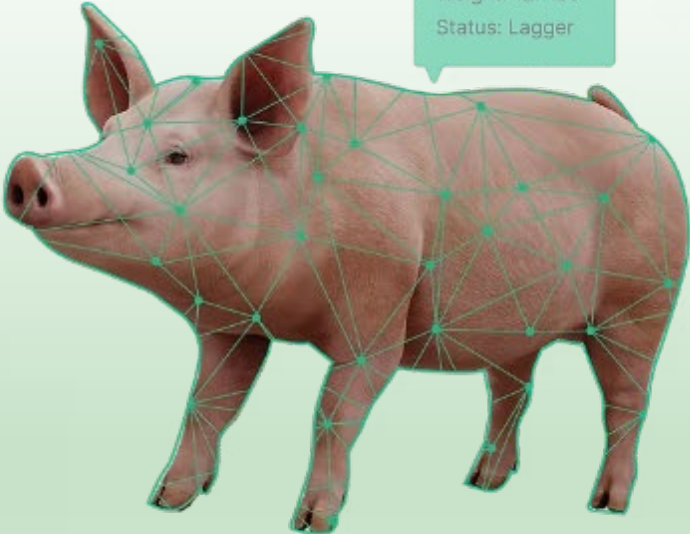

# Cattle Scan







## MOBILE ALERTS:



# BULLS:

## XTPRO SMART EAR TAG

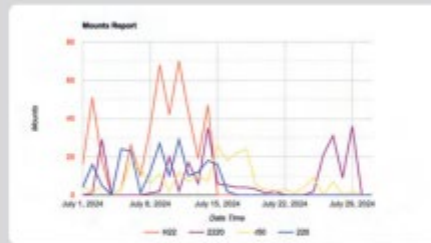

### BULL MOUNTING:

Compare mounting performance in multi-sire pastures and be alerted when mounting inactivity exists for 5, 10, or 21 days

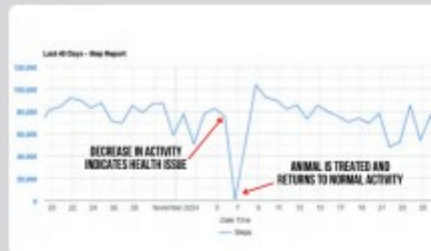

### HEALTH ALERTS - ILLNESS:

Get alerted of health issues including foot rot, pneumonia, and many other illnesses often multiple days before visual symptoms appear

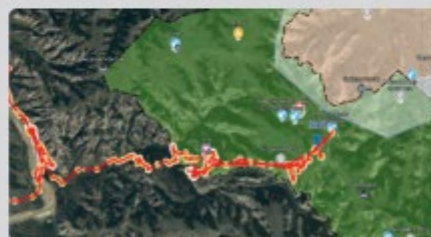

### GPS TRACKING:

5-minute GPS tracking allows you to know where your bulls are year-round and get alerted when an animal leaves its assigned fence







**Donut Labs**



- **Solid State!**
- **No liquid, no fire!**
- **-40C to +100C!**
- **5 minute charge!**
- **100,000 cycles!**
- **(50M miles!)**
- **400kwh/kg!**
- **No Rare Earth!**
- **No Lithium!**
- **Inexpensive!**
- **No cooling, any shape!**

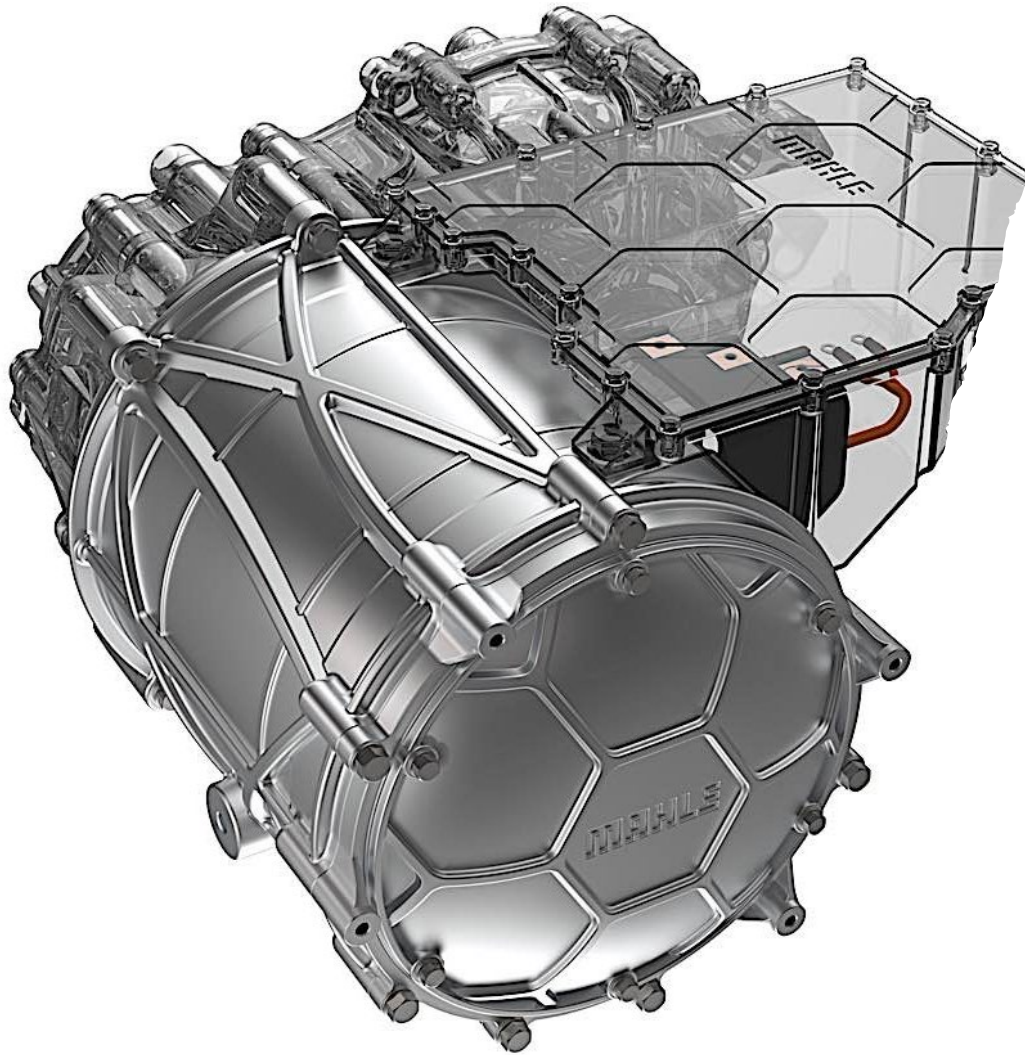

- Mahle's & ZF's new electric motors eliminate the need for rare earth metals.
- The motor uses wireless power transmission
- An advanced oil cooling system ensures reliable performance under heavy workloads
- With over 95% efficiency and high power density, the motor is ideal for heavy-duty applications





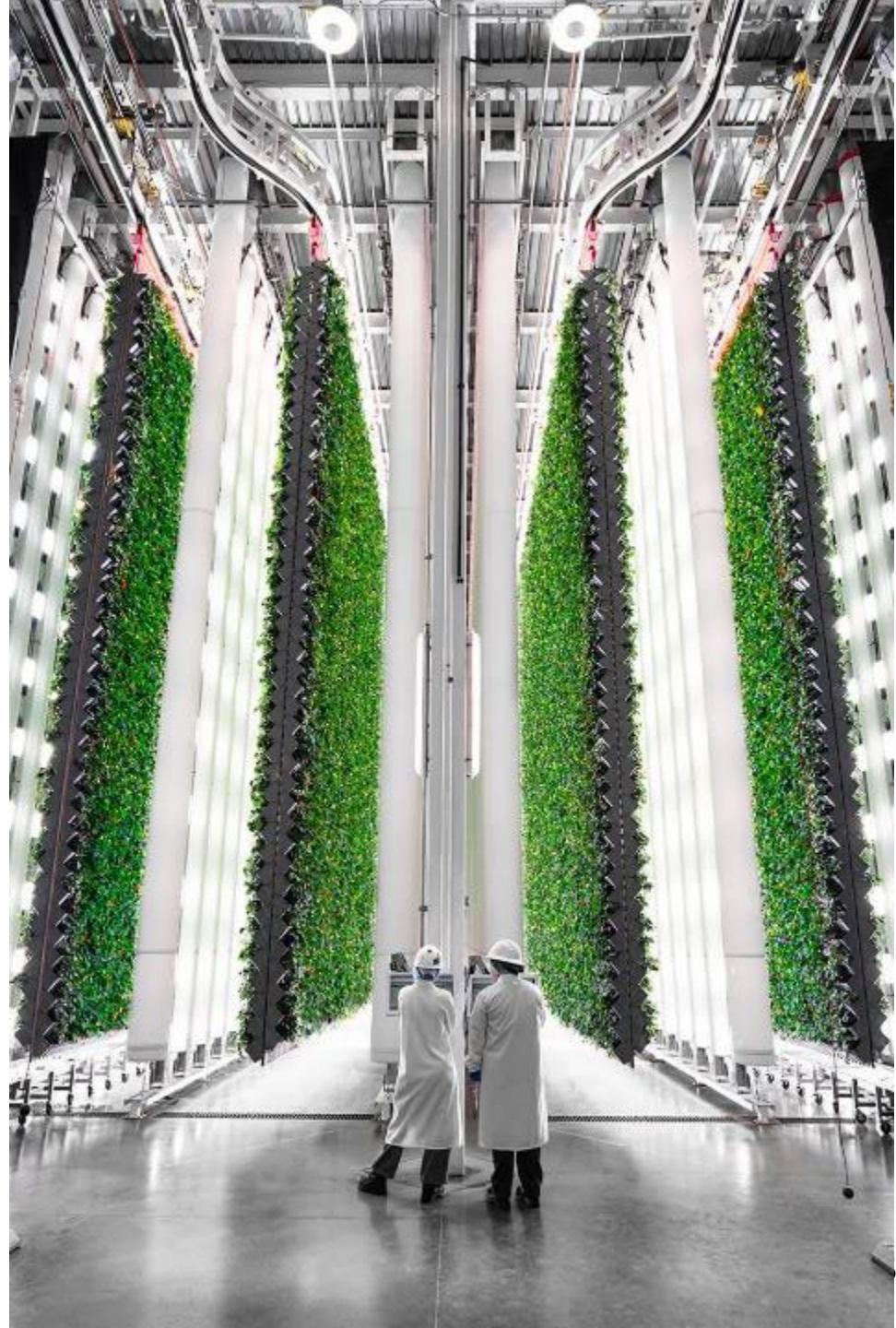



SF2080 (April 2023)

# Performance of Selected Commercially Available Asymbiotic N-fixing Products in the North Central Region



**Dave Franzen**, North Dakota State University and the following members of the NCERA-103 committee on non-conventional additives and amendments, and additional contributors:

**James Camberato**, Purdue University

**Emerson Nafziger**, University of Illinois, retired

**Daniel Kaiser**, University of Minnesota

**Kelly Nelson/Curkie Stock**, University of Missouri

**A**symbiotic or non-symbiotic N-fixing organisms, usually species of bacteria, have the ability to 'fix' nitrogen (N) from the atmosphere where it is abundant as  $N_2$  gas, and produce  $NH_3$  without being associated with plants or fungi. Fossil evidence indicates that asymbiotic N-fixers were present and active 1.5 billion years ago (Boyd and Peters, 2013). This compares to the appearance only about 59 million years ago of the more commonly known symbiotic N-fixing bacteria associated with legumes (Sprent and James, 2007).

The process used to fix N by asymbiotic organisms is highly energy intensive. The enzyme that serves as the fixation facilitator in bacteria is nitrogenase. To convert one molecule of  $N_2$  to one molecule of  $NH_3$ , this



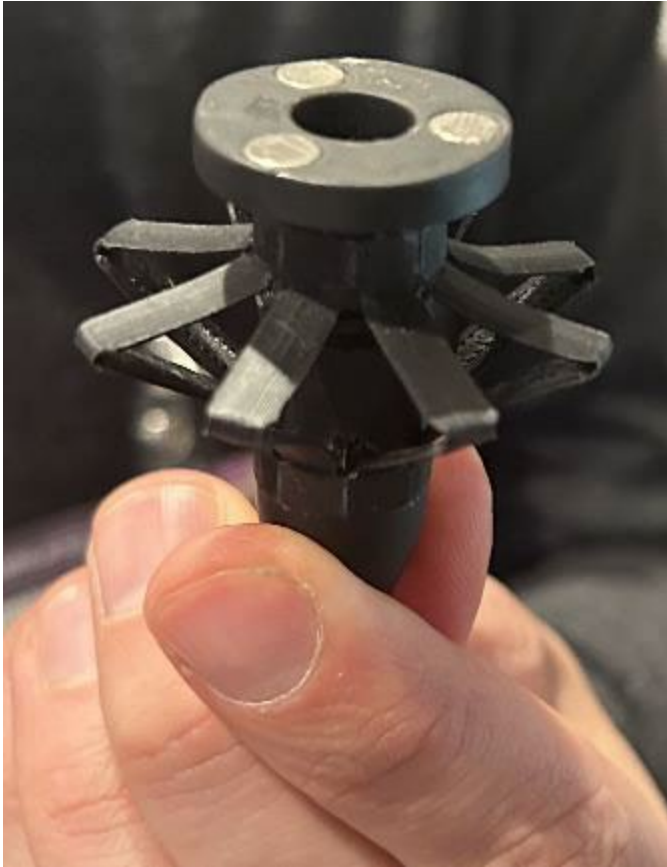

# 1820's Inventions:

- **First Electric Motor**
- **First Railways created**
- **First match invented**
- **Photography invented**
- **First internal combustion engine**
- **Modern Aluminum invented**
- **Modern Cement invented**
- **First typewriter**
- **Darwin's evolution theory**
- **Modern Textiles**
- **Synthesize Urea for the first time**
- **Fountain pen invented**
- **First Chocolate**
- **First accordion**

- Get involved!!**
- Be diligent about the consolidation of our input suppliers and our marketing options!!**
- Make sure independent data is still valued and created!!**
- Lobby our Government for a more reasonable and predictable registration process**



**Thank you!**  
**Scott Day**

[scott@fall-line-cap.com](mailto:scott@fall-line-cap.com)  
701-871-7688  
Scott Day P.Ag.

